

MD2010

Loop Detector is used to detect metal objects such as motor vehicles, motor bikes or trucks.

Features

- Wide supply range: 12.0 to 24 Volts DC
16.0 to 24 Volts AC
- Compact size: 110 x 55 x 35mm
- Selectable sensitivity
- Pulse or Presence setting for relay output.
- Power up and loop activation LED indicator

Application

Controls automatic doors or gates when a vehicle is present.

Description

Loop detectors in recent years have become a popular tool having innumerable applications in policing, right from surveillance operations to traffic control. Automation of gates and doors has become a popular usage of the loop detector.

The digital technology of the loop detector enables the equipment to sense a change in the inductance of the loop as soon as it detects the metal object in its path. The inductive loop which detects the object is made of insulated electrical wire and is arranged either as a square or rectangle shape.

The loop consists of several loops of wire and consideration should be giving to the loop sensitivity when installing on different surfaces. Setting the correct sensitivity allows the loops to operate with maximum detection. When detection occurs, the detector energises a relay for the output. This energising of the relay can be configured, to three different modes, by selecting the output switch on the detector.

Sensing Loop Position

A safety loop should be positioned where the largest amount of metal of the vehicle will be present when that vehicle is in the path of the moving gate, door or boom pole. Be aware that metal gates, doors or poles could activate the loop detector if they pass within range of the sensing loop.

- A free exit loop should be positioned +/- one and a half car lengths away from the gate, door or boom pole, on the approach side for traffic exiting.
- In cases where more than one loop is installed ensure there is at least a distance of 2m between the sensing loops to prevent cross-talk interference between the loops. (Also see Dip-switch 1 option and number of turns around the loop)

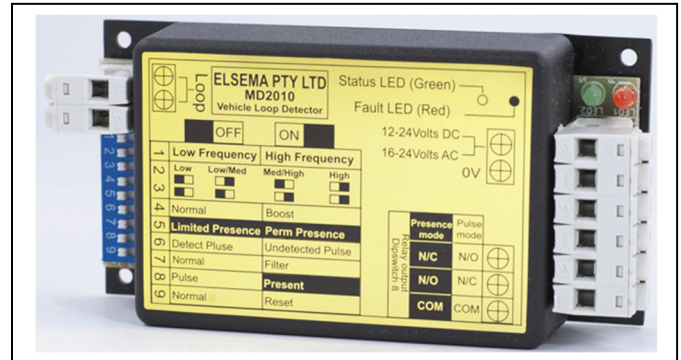

LOOP

Elsema stocks pre-made loops for easy installation. Our pre-made loops are suitable for all types of installations. Either for cut-in, concrete pour or direct hot asphalt overlay.







see www.elsema.com/auto/loopdetector.htm

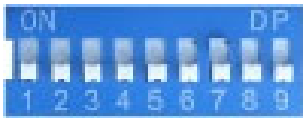



Detector position and installation

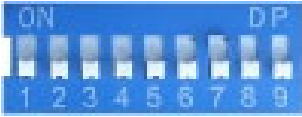

- Install the detector in a weatherproof housing.
- The detector should be as close to the sensing loop as possible.
- The detector should always be installed away from strong magnetic fields.
- Avoid running high voltage wires near the loop detectors.
- Do not install the detector on vibrating objects.
- When the control box is installed within 10 metres of the loop, normal wires can be used to connect the control box to the loop. More than 10 metres requires the use of a 2 core shielded cable. Do not exceed 30 metres distance between control box and loop.

Dip-switch Settings

<u>Feature</u>	<u>Dip Switch settings</u>	<u>Description</u>
Frequency setting (Dip switch 1)		
High Frequency	Dip switch 1 "ON" 	This setting is used in cases where two or more loop detectors and sensing loops have been installed. (The sensing loops and detectors should be positioned at least 2m apart). Set one detector to high frequency and the other set to low frequency to minimize the effects of cross-talk between the two systems.
Low Frequency	Dip switch 1 "OFF" 	

<u>Feature</u>	<u>Dip Switch settings</u>	<u>Description</u>
Loop Sensitivity (Dip switch 2&3)		
Low sensitivity 1% of loop frequency	Dip switch 2 & 3 “OFF” 	This setting determines the necessary change to the loop frequency to trigger the detector, as metal passes across the sensing loop area.
Low to medium sensitivity 0.5% of loop frequency	Dip switch 2 “ON” & 3 “OFF” 	
Medium to high sensitivity 0.1% of loop frequency	Dip switch 2 “OFF” & 3 “ON” 	
High sensitivity 0.02% of loop frequency	Dip switch 2 & 3 “ON” 	
Boost Mode (Dip switch 4)		
Boost mode is OFF	Dip switch 4 “OFF” 	If boost mode is ON the detector will immediately switch to high sensitivity once activated. As soon as the vehicle is no longer being detected the sensitivity reverts back to what has been set on dipswitch 2 and 3.
Boost mode is On (Active)	Dip switch 4 “ON” 	This mode is used when the height of the undercarriage of a vehicle increases as it passes over the sensing loop.

<u>Feature</u>	<u>Dip Switch settings</u>	<u>Description</u>
Permanent presence or limited presence mode (When presence mode selected. See dip-switch 8) (Dip switch 5) This setting determines how long the relay remains active when a vehicle is stopped within the sensing loop area.		
Limited presence mode	Dip switch 5 “OFF” 	With limited presence mode, the detector will only activate the relay for 30 min. If the vehicle has not moved out of the loop area after 25 min, the buzzer will sound to alert the user that the relay will deactivate after another 5 min. Moving the vehicle across the sensing loop area again, will re-activate the detector for 30 min.
Permanent presence mode	Dip switch 5 “ON” 	The relay will remain active for as long as a vehicle is detected within the sensing loop area. When the vehicle clears the sensing loop area, the relay will deactivate.
Relay Response (Dip switch 6)		
Relay response 1	Dip switch 6 “OFF” 	Relay activates immediately when the vehicle is detected in the sensing loop area.
Relay response 2	Dip switch 6 “ON” 	Relay activates immediately after the vehicle leaves the sensing loop area.
Filter (Dip switch 7)		
Filter “ON”	Dip switch 7 “ON” 	This setting provides a 2 sec delay between detection and relay activation. This option is used to prevent false activations when small or fast moving objects pass through the loop area. This option can be used where an electric fence nearby is the cause of false activations. If the object does not remain in the area for 2 sec the detector will not activate the relay.

<u>Feature</u>	<u>Dip Switch settings</u>	<u>Description</u>
Pulse mode or Presence mode (Dip switch 8)		
Pulse mode	Dip switch 8 "OFF" 	Pulse mode. Relay will activate for 1 sec only on entry or exit of sensing loop area as set by dip-switch 6. To re-activate the vehicle must leave the sensing area and re-enter.
Presence mode	Dip switch 8 "ON" 	Presence mode. Relay will remain active, as per dip-switch 5 selection, for as long as a vehicle is within the loop sensing area.
Reset (Dip switch 9)		
The MD2010 must be reset every time a setting change is made to the Dip-switches		
Reset	Dip switch 9 "ON/OFF" 	To reset, switch dip-switch 9 on for approximately 2 seconds and then off again. The detector then completes the loop test routine.

*Please note: The MD2010 must be reset every time a setting change is made to the Dip-switches

Relay status:

Relay		Vehicle Present	No vehicle present	Loop faulty	No Power
Presence mode	N/O	Closed	Open	Closed	Closed
	N/C	Open	Closed	Open	Open
Pulse mode	N/O	Closes for 1 sec	Open	Open	Open
	N/C	Opens for 1 sec	Closed	Closed	Closed

Power up or Reset (Loop testing)

On power up the detector will automatically test the sensing loop.

Ensure the sensing loop area has been cleared of all loose pieces of metal, tools and vehicles before powering up or resetting the detector!

Loop status is showed in the below table:

Loop Status	Loop is open or loop frequency too low	Loop is short circuited or loop frequency too high	Good loop
Fault LED	3 flashes after every 3sec Continues Until loop is corrected	6 flashes after every 3sec Continues Until loop is corrected	All three the Detect LED , Fault LED and the buzzer will beep/flash (count) between 2 and 11 times to indicate the loop frequency. 1 count = 10KHz 3 counts x 10KHz = 30 – 40KHz
Buzzer	3 beeps after every 3sec Repeats 5 times and stops	6 beeps after every 3sec Repeats 5 times and stops	
Detect LED	-	-	
Solution	1. Check if loop is open. 2. Increase the loop frequency by adding more turns of wire	1. Check for short circuit in the loop circuit 2. Reduce the number wire turns around the loop to reduce the loop frequency	

Power up or Reset Buzzer and LED indications)

Buzzer and LED indication:

Detect LED	
1 sec flashes 1 sec apart	No vehicle (metal) detected in loop area
On permanently	Vehicle (metal) detected in loop area
Fault LED	
3 flashes 3 sec apart	Loop wire is open circuit. Use Dip-switch 9 after any change has been done.
6 flashes 3 sec apart	Loop wire is short circuited. Use Dip-switch 9 after any change has been done.
Buzzer	
Beeps when vehicle is present	Buzzer beeps to confirm the first ten detections
Continuous beep with no vehicle in the loop area	Loose wiring in loop or power terminals Use Dip-switch 9 after any change has been done.

Elsema Pty Ltd

31 Tarlington Place, Smithfield
NSW 2164
Ph: 02 9609 4668
Website: www.elsema.com

Distributed by: