

GLR43301

Single Channel 433MHz Gigalink™ Receiver with Timer Controlled Relay Output

Features

- Supply voltage can be 12 – 24 Volts AC or DC
- Highly sensitive receiver input stage. When used with GLT433... transmitters an operating range of 350 metres (980 ft) is possible.
- One relay output. Can switch loads up to 8 Amps.
- Crystal controlled for high stability and performance.
- Uses micro-controller technology that can be re-programmed to suit unique applications.
- Momentary, latching, timed and security latching output modes can be selected by the user. Changing the settings on the four-way dip switch does this
- Power ON LED indicator



Applications

- Automatic gates.
- Security systems.
- Timer controlled outputs.
- Simple on/off functions.

Description

The GIGALINK™, GLR43301 is the **most advanced Remote Control technology** available in the world today. GIGALINK™ is an invention that has revolutionised the entire Remote Control technology including Elsema's earlier version of FMT- ... and FMR- ... series.

The GLR43301 state-of-the-art invention brings a new dimension in the world of Remote Control technology in domestic, **commercial and industrial** applications.

The innovative microcontroller technology replaces the traditional dip switch coding which **eliminates** any possible **code grabbing**. Special features such as over four billion code combinations and ability to program any number of transmitters to a receiver adds up to the most advanced and secure Remote Control available.

The receiver has a relay output that is activated when the GLR43301 receives the correct code from the GIGALINK™ transmitter. The relay out has voltage free contacts. Contacts available are “C” Common, “NC” Normally Closed and “NO” Normally Open.

Code Programming







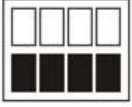

For code programming, please refer to the separate programming instructions.

Unique Code System

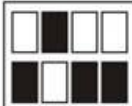
The microcontroller EEPROM allows large volume users to have a unique code. This enables Elsema to offer OEM manufacturers “their own” radio control.

Changing the Four-Way Dip Switch

The GLR43301 has a 4-way dip switch which allows the user to select between several different output modes. This is shown below:

DIP Switch Mode Settings	
The output relay will respond in the following manner when receiving the correct signal from a transmitter	
<p>1 2 3 4</p> 	"Momentary": Relay on, only while correct signal is received
	"Latching": Relay alternates at every correct incoming signal
	"Delayed Off 1": Relay on, but delayed off for 1-10 seconds, adjustable by trimpot
	"Delayed Off 2": Relay on, but delayed off for 10-300 seconds, adjustable by trimpot
	"Pulsing": Relay will pulse at 1Hz for 10-300 seconds, adjustable by trimpot
	"Security latching On": Relay will energize until supply to receiver is momentarily interrupted
	"On-Off": This mode requires a 2-channel Tx. Channel 1 will always energize the relay Channel 2 will always de-energize the relay <i>To use this mode you need to do channelised code programming. Do not use single code programming.</i>
	"On-Off": This mode requires a 4-channel Tx. Channel 3 will always energize the relay Channel 4 will always de-energize the relay <i>To use this mode you need to do channelised code programming. Do not use single code programming.</i>
	"Test": Relay is energized, for test purpose only

Output Modes

Relay output on the receiver by default the mode is set to momentary. Other modes are selectable from the 4-way dipswitch.

Factory Default = Momentary

Momentary - Output is active for as long as the transmitter button is pressed.

This is a standard mode on most automatic gates or garage door openers.

Latching - Output remains active until next press of the transmitter button.











Similar to switching "on" and "off" a light.

Security Latching - Output remains active until power to the receiver is removed. Similar to security alarms and fire alarms.

Customised Software

Custom output modes can be programmed to do special functions. Call Elsema for more details.

Products in the Range

				
GLR43301 1-Channel	GLR43301240 1-Channel, 240V	GLR43302 2-Channel	GLR43302240 2-Channel, 240V	GLR4330312, 3-Channel, 12 - 24V
				
GLR4330412 4-Channel, 12 - 24V	GLR43304240 4-Channel, 240V	GLR43308 8-Channel	GLR43308R 8-Channel Relay Output	GLR43302SS Receiver with 6-way female connector GLR43302SST Receiver with terminal block

Technical Data

Supply Voltage	12 – 24 Volts AC or DC. Can use Elsema's AC power pack (12PP-1000) Supply lines should be less than 3 metres long to comply with radio frequency authorities.
Current Consumption	16 mA on standby at 12 VDC supply 45 mA if relay "ON" at 12VDC supply
Receiving Frequency	433.920MHz (Other frequencies available on request. Refer to the table below)
Operating Temperature Range	-5 to 50°C
Outputs	Change over relay output, rated at 8 Amps/240 Volts
Connections	6-way screw type terminal block
Antenna	Elsema's ANT433MHz series antennas or piece of approximately 690 mm long wire for short range applications.
Dimensions	95 X 70 X 30 mm
Mounting hole size	3.97 mm or 5/32"
Useable Transmitters	All Elsema Type 433MHz GLT-... series

Available Frequencies

SF2	433.664 MHz
SF3	433.408 MHz
SF4	433.152 MHz
SF5	434.688MHz
SF6	434.432 MHz

Special Frequency products can be made upon request. There is a minimum quantity order of 20. Please quote Correct SF number when ordering transmitters on special frequencies.

AC/DC Supply and Antenna

AC/DC power supply and antenna is connected to the terminal block marked + and -. The shield of the antenna coaxial cable should be connected to the minus (-) terminal block.

Do not connect the AC/DC supply to the 2.5-mm coding socket since connection may damage the microcontroller.

Case

The GLR43301 can be supplied without a case; this allows the receiver to be integrated according to your needs. The C125 case can be used to enclose the GLR43301 receiver. The receiver with a case is known as a GLR43301E.

Block Diagram

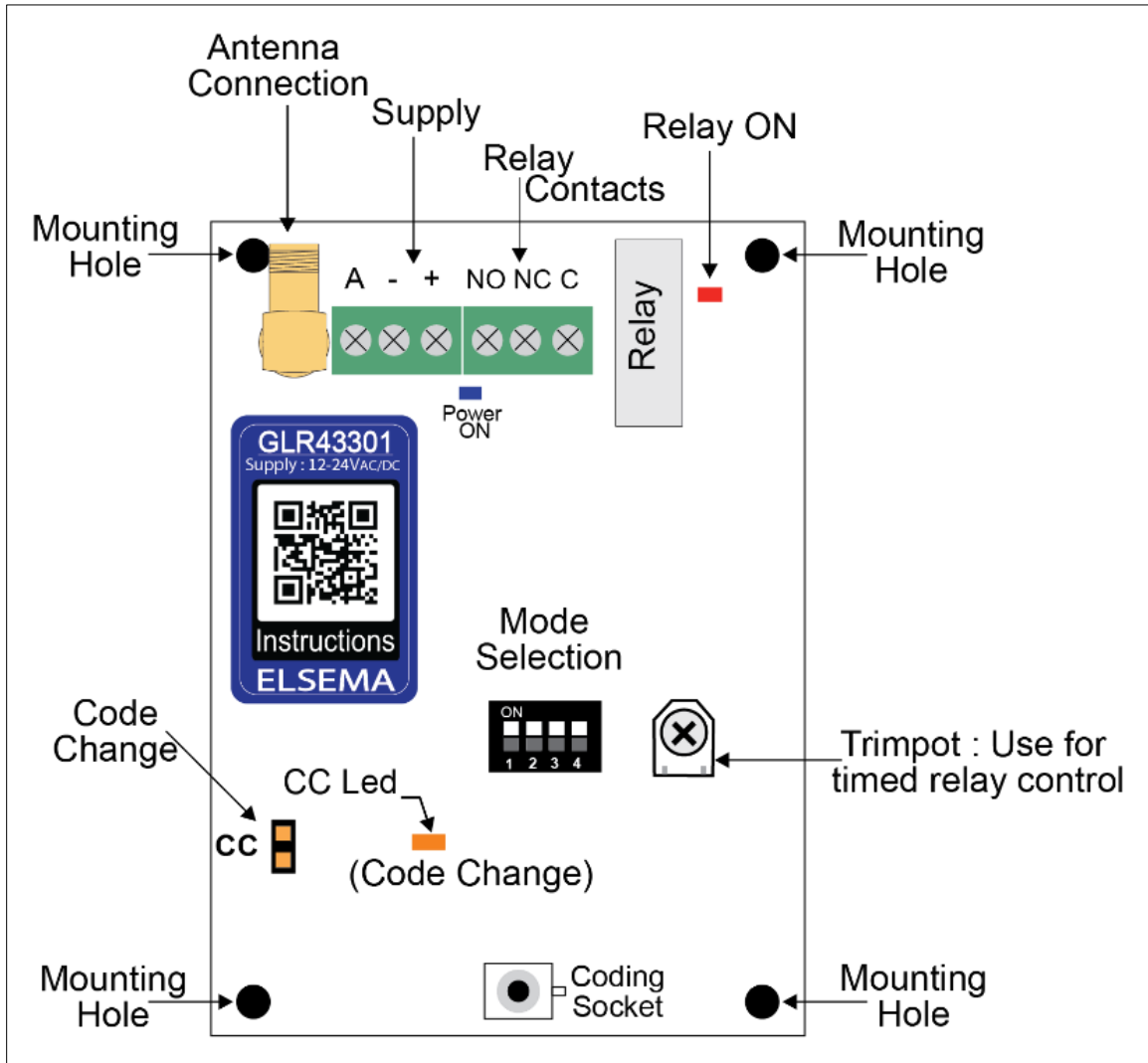

GLR43301 12/24 VAC/DC Application

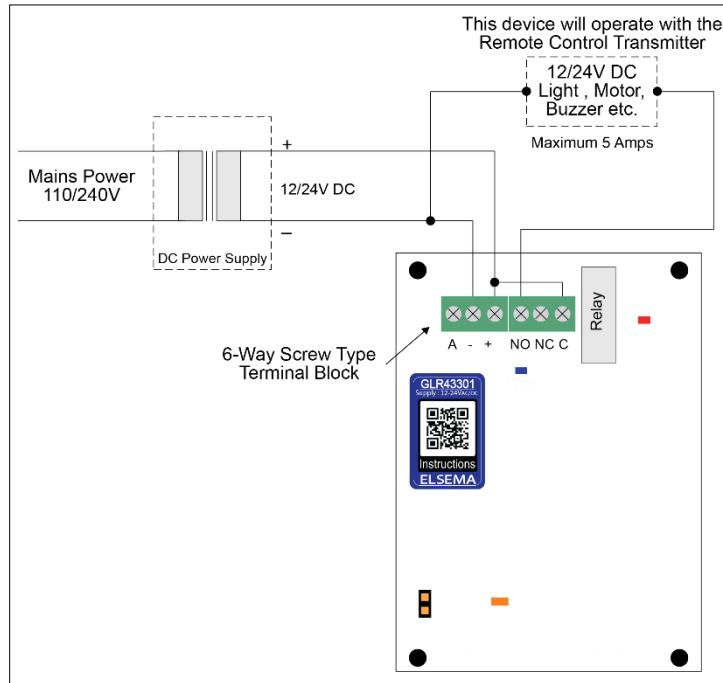

GLR43301 240/110 VAC Application

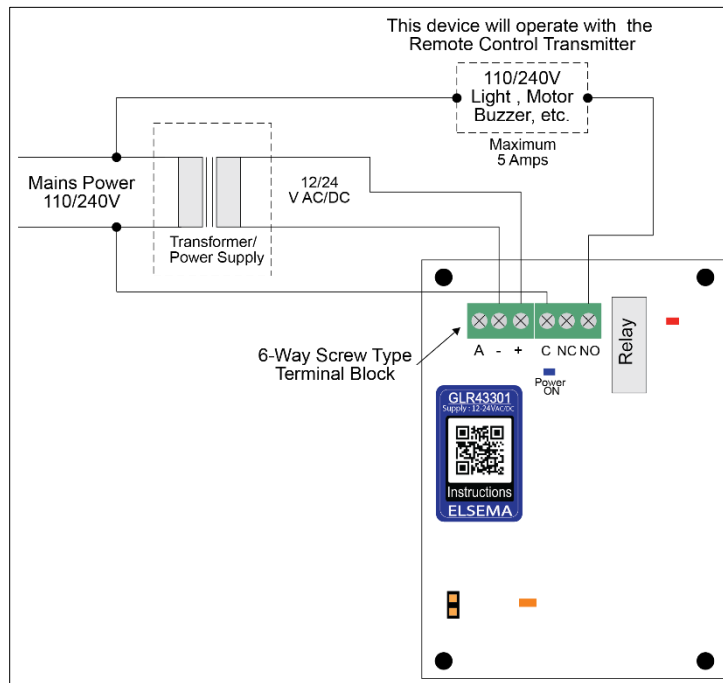

Manufactured by

Elsema Pty Ltd
 31 Tarlington Place, Smithfield
 NSW 2164, Australia.
 Ph: 02 9609 4668
 Website: <http://www.elsema.com>